

Instruction Guide

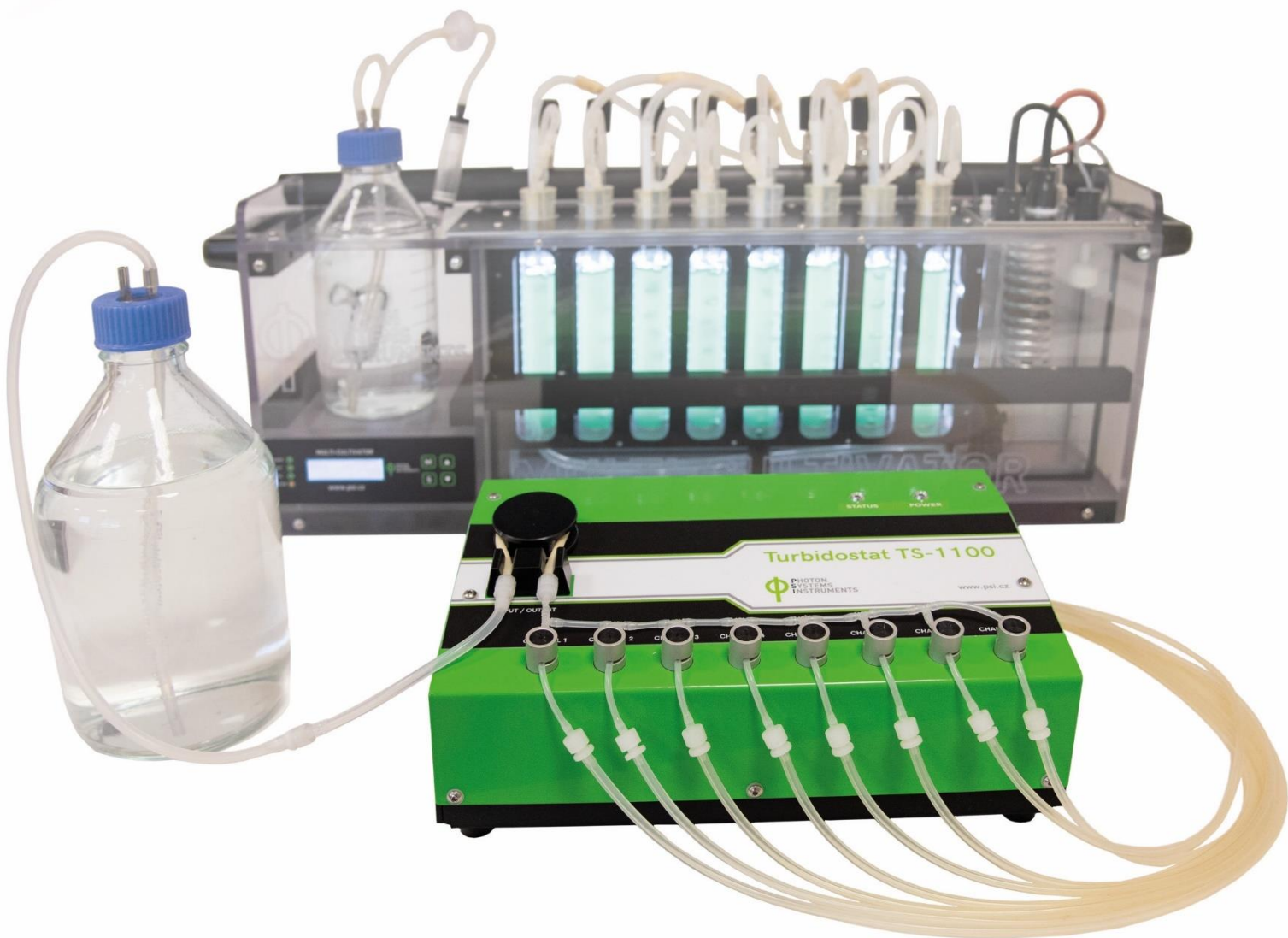

Turbidostat TS - 1100

Please read the Guide before operating this product



Manual Version: 2022/08

© PSI (Photon Systems Instruments), spol. s r.o.

www.psi.cz

This document and its parts can be copied or provided to a third party only with the express permission of PSI.

The contents of this manual have been verified to correspond to the specifications of the device. However, deviations cannot be ruled out. Therefore, a complete correspondence between the manual and the real device cannot be guaranteed. The information in this manual is regularly checked, and corrections may be made in subsequent versions.

The visualizations shown in this manual are only illustrative.

This manual is an integral part of the purchase and delivery of equipment and its accessories and both Parties must abide by it.

TABLE OF CONTENTS

1	Information before Using Turbidostat Module TS 1100	5
2	General Information	6
3	Components of the Turbidostat Module	7
4	Description of the Turbidostat Module	8
5	Care and Maintenance	9
6	Turbidostat Pump Calibration	10
7	Installation	11
8	Operation Instructions	13
9	Warranty Terms and Conditions	17
10	List of Pictures	18

1 INFORMATION BEFORE USING TURBIDOSTAT MODULE TS 1100

Read this manual carefully before operating the device. If you are not sure about something in the manual, contact the manufacturer for clarification.

	By accepting the device, the customer agrees to follow the instructions in this guide.
---	--



GENERAL CAUTIONS:

- Always follow corresponding manuals while working with the Turbidostat module or doing the maintenance.
- It is forbidden to interfere with the hardware or software of the Turbidostat module in any way without previous agreement with the manufacturer.
- The manufacturer is not responsible for any damage due to improper operation.

GENERAL ELECTRICAL SAFETY GUIDELINES:

- Perform a routine check of the devices and their wiring.
- Use only cables supplied by the manufacturer.
- Replace worn or damaged cords immediately.
- Do not perform any alterations to the electrical parts of the device or its components.

The following table presents basic highlight symbols used in this manual:

Symbol	Description
	Important information, read carefully.
	Complementary and additional information.

Tab. 1 Used symbols.

2 GENERAL INFORMATION

The Turbidostat module TS 1100 enables to run a continuous cultivation in the Multi-Cultivator MC 1000. In the basic setup, the Multi-Cultivator's optical sensing unit monitors the optical density (OD) of the biomass and depending on the actual value, the Turbidostat module adds fresh medium to maintain a preset OD level. Each cultivation vessel can be controlled separately. The fresh medium is delivered by a peristaltic pump at a controlled flow rate through 8 independent pinch valves. Fig. 1 shows a schematic diagram of the Turbidostat module setup with the cultivation system.

The OD of each culture vessel, and therefore biomass concentration, is monitored either through OD680 or OD720 measurement. The OD can be set to a constant level or set to change over a specific range. Many various turbidostatic cycles can be specified for each vessel in a particular experiment.

The peristaltic pump flow rate runs between 0.2 – 50 ml/min. The pumping speed can be set for each culture vessel independently.

The excess liquid from each culture vessel flows spontaneously into the waste bottle. Therefore, the working biomass volume in each culture vessel is influenced by level of the effluent tube outlet and by aeration flow rate.

The latest Turbidostat module TS 1100 accommodates its own TS Air pump to guarantee a sufficient air supply and mixing of the biomass in all test vessels.

The Bioreactor control software enables full control of the turbidostatic cultivation and also the remote access to the system. The Bioreactor control software provides an information about the fresh medium consumption in each culture vessel which can be used to calculate the growth rate.

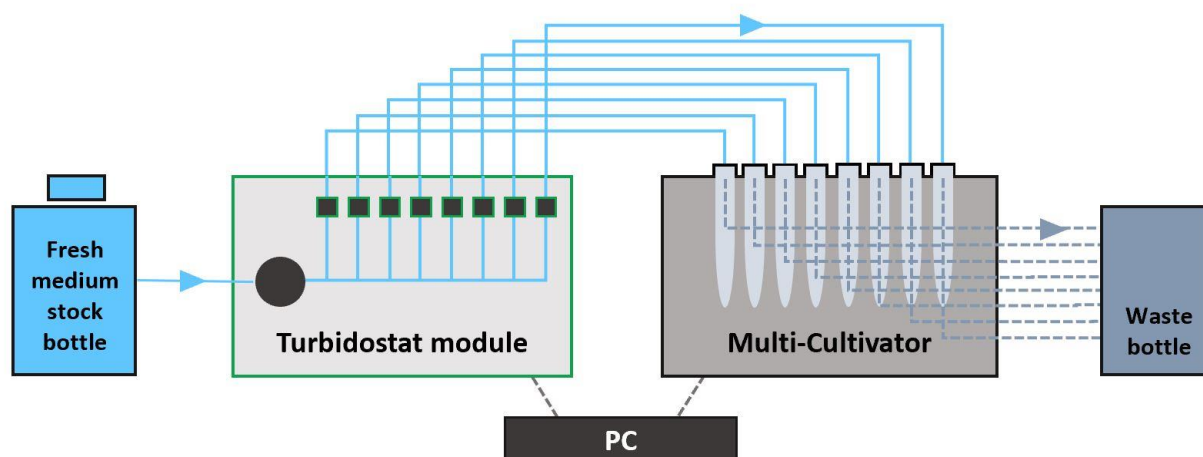

Fig. 1 Schematic diagram of Turbidostat module TS 1100 coupled with the Multi-Cultivator MC 1000.

Principle of the turbidostatic regulation by TS 1100

The Turbidostat module uses "the turbidostatic OD" to maintain the preset turbidostatic cultivation. The turbidostatic OD is measured automatically for each cultivation vessel every 1 min. This default timing is predefined by the manufacturer and cannot be changed. The turbidostatic OD values are used just as a feedback regulator to control the turbidostatic cultivation and are not visualized, recorded and exported. Contrary to that, the standard OD measurement that is set by user via the Bioreactor control software is displayed in the live Graph, saved to the database and can be exported (refer to the Bioreactor Software Manual for more details).

In Turbidostat module, one peristaltic pump and eight pinch valves serve 8 cultivation vessels. The flow of the medium into the vessel is controlled by a related pinch valve that is in the open or closed state depending on the actual turbidostatic OD reading in the vessel. The Turbidostat module starts to dilute the algal culture once the preset turbidostatic OD value is reached. Each cultivation vessel is diluted for 5 seconds (using a preset flow rate) and after that the system switches to the next vessel. After checking of all 8 vessels the Turbidostat module waits for the next turbidostatic OD measurement (performed every 1 minute) and based on these measurements the software determines whether or not to continue the dilution process.

3 COMPONENTS OF THE TURBIDOSTAT MODULE

Please, unpack the carton carefully. Check if the package contains the following items (Fig. 2):

Component number	Component description	Specification	Pcs
1	Turbidostat module		1
2	Power unit	12 VDC (input 110 – 230 VAC)	1
3	Communication cable		1
4	Silicone plug with the medium inlet	∅ 29x23, 30 mm	8
5	Metal or plastic lid with ports and silicone ring	Silicon ring 27x42x2 mm	1+2
6	Red screw cap with hole GL45		1
7	Norprene A-60-F pressure tubing	∅ 4/6, 154 mm	6
8	Tygon 3350 pressure tubing	∅ 1.6/3.2 mm	3 m
9	Silicone tubing	∅ 2/5 mm	25 m
10	Male Luer Integral Lock Ring MTL240-J1A	5/32" (4.0 mm)	4
11	Female Luer Thread Style FTLL240-J1A	5/32" (4.0 mm)	4
12	Male Luer Integral Lock Ring MTL220-J1A	3/32" (2.4 mm)	16
13	Female Luer Thread Style FTLL220-J1A	3/32" (2.4 mm)	18
14	Tee Tube Fitting T220-J1A	3/32" (2.4 mm)	14
15	Set of 20 glass aeration tubes for MC		1
16	Service key		1
17	Instruction manual		1
18	Turbidostatic pump calibrator software (USB flash drive)	For turbidostatic pump calibration	1
19	Minisart syringe filter	PTFE, 0.2 µm; Sartorius	1

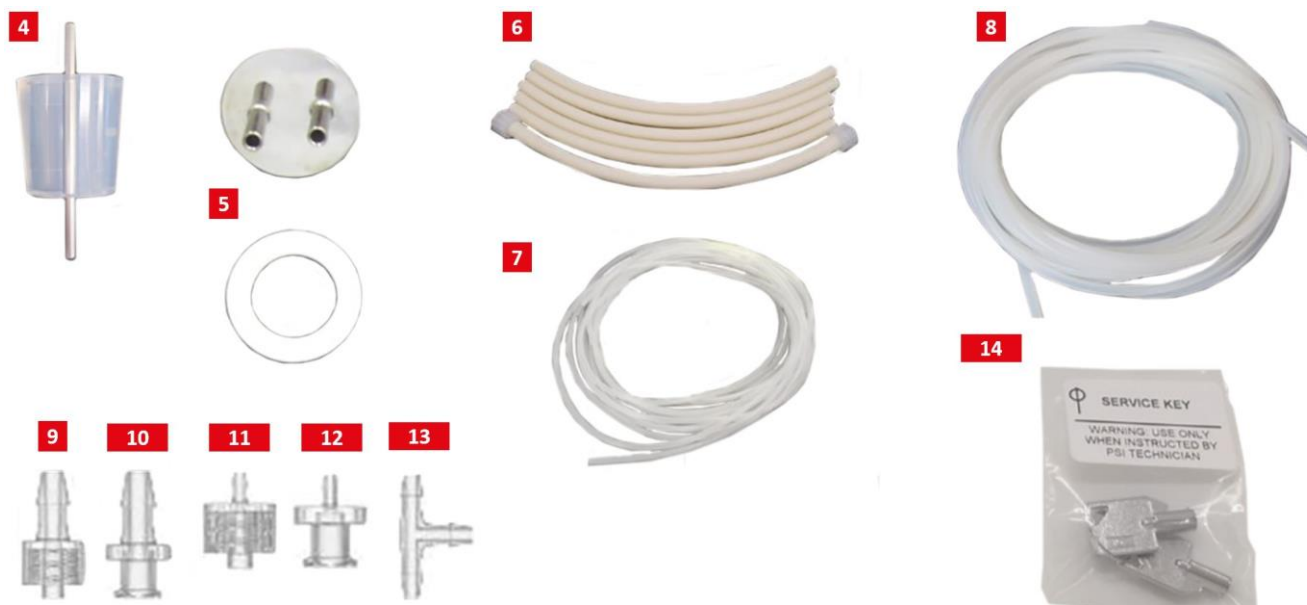

Fig. 2 Components of the Turbidostat module.



If any item is missing, please, contact the manufacturer. Please check the parcel for any visible external damage. If you find any damage, notify the carrier and PSI immediately. The carton and all packing materials should be retained for inspection by the carrier or insurer. For customer support, please contact: support@psi.cz

4 DESCRIPTION OF THE TURBIDOSTAT MODULE

The hardware of the Turbidostat module comprises one peristaltic pump, 8 pinch valves with controlling electronics. The peristaltic pump carries the fresh medium from the medium stock bottle into a medium dispenser tubing. The fresh medium is then distributed via pinch valves into the individual cultivation vessels. The flow of the fresh medium depends on the preset OD (either OD680 or OD720) value and the required volume of medium to reach that value. The excess liquid from each culture vessel flows spontaneously into the waste bottle (not included in the standard system).

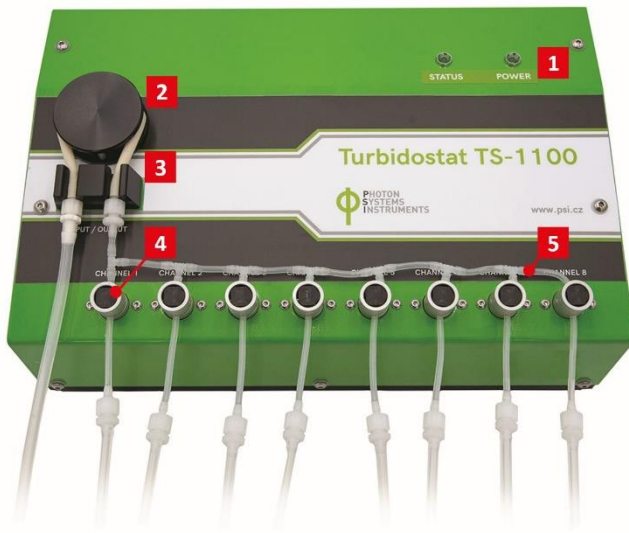

The flow rate of the peristaltic pump runs between 0.2 – 50 ml/min. The rotor with four rollers rotates clockwise. The flow rate of medium to each culture vessel and the level of OD680 or OD720 to be maintained can be set for each vessel independently.

See description of the individual features and ports of the Turbidostat module in Fig. 3 and Fig. 4.

Fig. 3 Main panel of the Turbidostat module.

1) Status control LED. 2) Rotor of the peristaltic pump. 3) Peristaltic tubing holder: input + output. 4) Pinch valve. 5) System of fresh medium dispenser tubing.

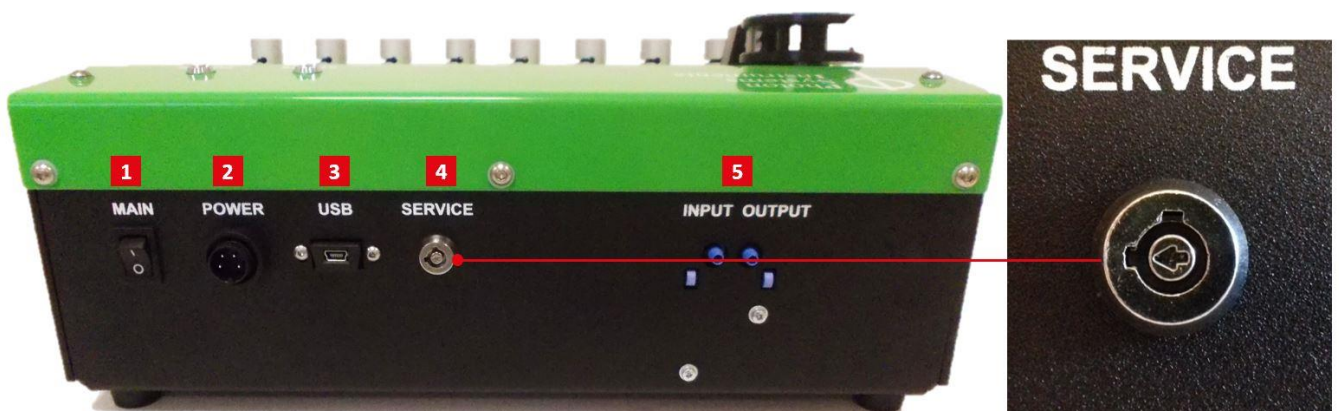

Fig. 4 Rear panel of the Turbidostat module.

1) Main switch. 2) Power supply plug. 3) USB A-B communication port. 4) Port for the service key - the arrow in the middle must be in the horizontal position). 5) Inbuilt TS Air pump input and output.



Please, do not touch the metal service button (4) on the rear side of the device without PSI manufacturer directions. The arrow should be left in the horizontal position (see Fig. 4).

The new Turbidostat module 1100 accommodates its own turbidostatic Air pump (TS Air pump) to guarantee a continuous air supply and mixing of the biomass in all testing vessels. The TS Air pump has higher power compared to the standard Multi-Cultivator's Air pump. Typically, the range of TS Air pump runs between 1.1 – 1.8 l/ml under recommended connection with an air filter connected to the input tubing. This range corresponds to an intensity of approximately 25 – 70 % that can be adjusted by the Bioreactor control software (see Fig. 5). The input and output of the TS Air pump is located on the rear side of the Turbidostat module (Fig. 5).

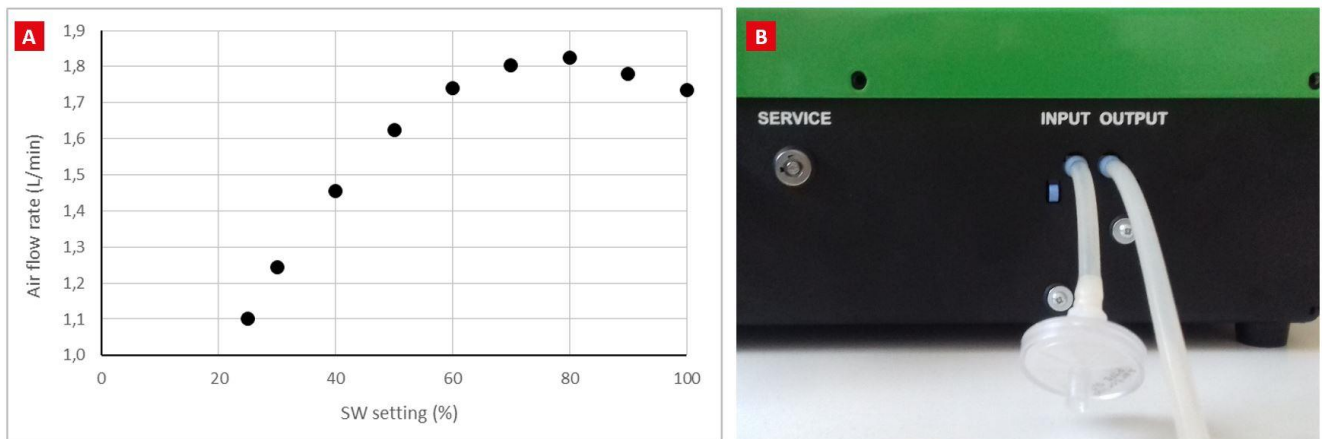

Fig. 5 TS Air pump.

A) An illustrative relation of the SW Setting (%) and Air flow rate (l/min) of the pump in case there is a filter connected to the input tubing. B) Rear side of the Turbidostat module 1100 - TS Air pump input and output.

5 CARE AND MAINTENANCE

- Loosen the tubing when pump is not used. The tubing is under permanent tensile stress and it can get deformed over time and subsequently lose elasticity if compressed for a long period.
- Keep the tubing and rotor clean. If any solution (including water) spills on any part of the device, clean the device. Certain solvents, such as strong detergents and acids, can permanently damage the pump.
- If visible signs of wear are seen on the tubing, the tubing should be replaced.
- Use only compatible tubing that came with the unit or substitute it for tubing of the same size (length, diameter and wall thickness).
- There are no user-serviceable parts inside the pump. Unauthorized modification or repair will avoid the warranty.
- All the tubing and Luer Connectors including Tee Tube Fittings are autoclavable.

6 TURBIDOSTAT PUMP CALIBRATION

The peristaltic pump needs to be calibrated for delivery of exact liquid volume in a given time. The calibration is performed using the external application Pump Calibrator that can be found on the delivered USB flash drive. Pump Calibrator runs on Windows OS.

- Set up the Turbidostat module for the calibration as is shown in Fig. 6 (see more instructions in chapter 7 of this manual).
- The same tubing should be used during calibration procedure and subsequent experiments. The calibration accuracy is influenced by the length of the tubing around the pump rollers (pressure tubing) and so, the pressure tubing should not be replaced after the calibration. Please remember, that the length of pressure tubing may change slightly during the autoclaving.
- Connect the Turbidostat module to the power and switch it on.
- Install the Pump Calibrator application on PC with Windows operating system.
- Connect the Turbidostat module to PC with Pump Calibrator via the USB cable provided.
- Start the PumpCalibrator.exe file. The Turbidostat module should be detected automatically. If not, click on **Detect** button (Fig. 7). In case, the PC still cannot recognize the Turbidostat module, please change the setting of the appropriate COM port on your PC.
- Fill the entire tubing system with distilled water by starting the system – click **Start** in the calibration app window - and then interrupt it after the tubing is filled.
- Empty the measuring cylinder of any water.
- Set pump speed (ml/min) required for the calibration and the calibration duration of 60 sec in the software.
- Start the calibration process by pressing **Start** button.
- Measure the water volume collected in the cylinder during the 60 sec period of the calibration run.
- This is the real volume pumped by the system per minute and the value should be entered in the “Pumped Volume” field to correct the calibration.
- Save the new calibration by pressing **Save** button.

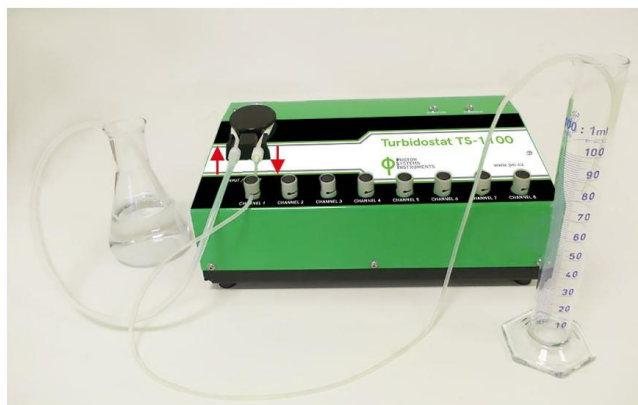

Fig. 6 Set up of Turbidostat module for calibration.

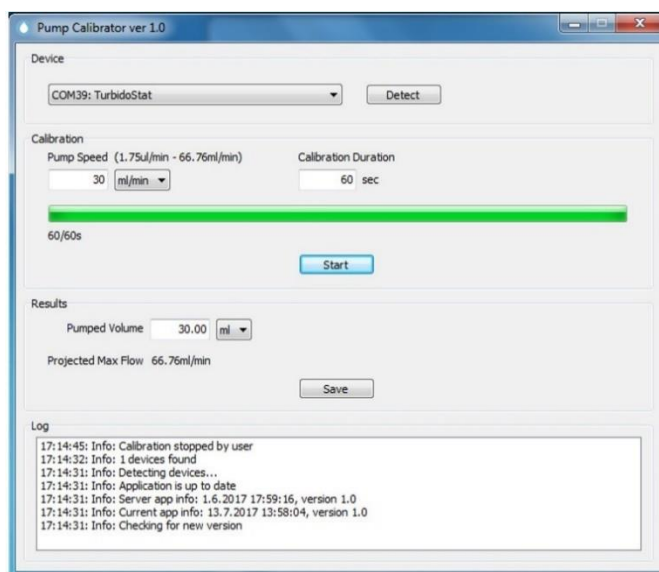

Fig. 7 Turbidostatic pump calibrator window.

7 INSTALLATION

- Setup the Multi-Cultivator MC 1000 for cultivation according to the instructions in the Multi-Cultivator MC 1000 instruction manual and connect it to the Bioreactor control unit (PC) via the communication cable provided.
- Use special silicon plugs for the culture vessels when used with Turbidostat module (Fig. 2, item 4). These have an additional inlet built in for the automatic addition of the fresh medium to the culture.
- Assemble the medium dispenser tubing as is shown in Fig. 8. Use appropriate tubing for rotor of the peristaltic pump, pinch valves and medium dispenser as described below.
- Use Norprene A-60-F pressure tubing around the main rotor of the peristaltic pump.
- Use Tygon pressure tubing 3350 for the 8 pinch valves: feed precut piece of the Tygon tubing through the pinch valve and connect it through Luer fittings with the remaining medium dispenser tubing system.
- Use silicone tubing \varnothing 2/5 mm for the individual medium dispenser branches.
- For connection of different tubing pieces use corresponding connectors and tee fittings as described below (Fig. 8).

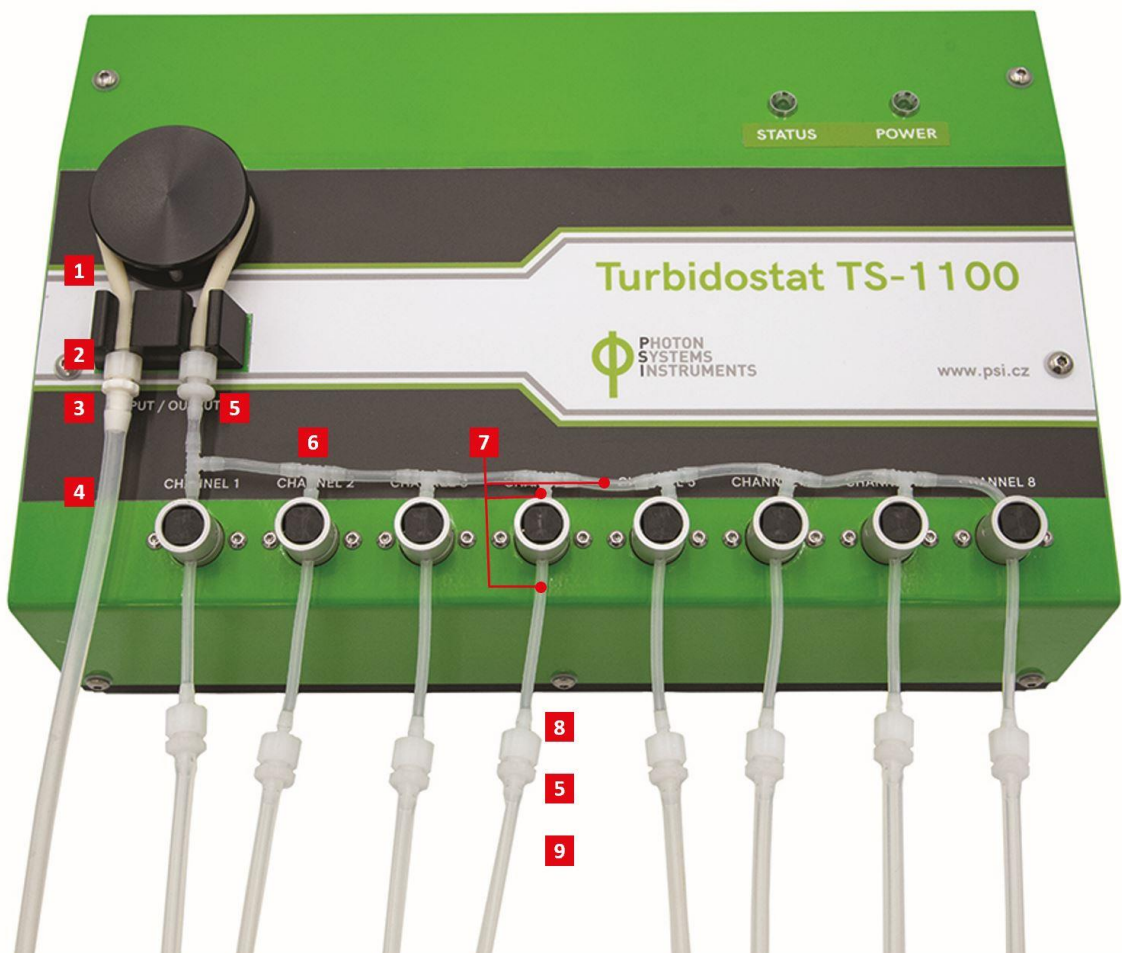

Fig. 8 Assembling of the fresh medium dispenser tubing.

1) Norprene A-60-F pressure tubing. 2) Male Luer lock ring MTL240. 3) Female Luer thread FTLL240. 4) The fresh medium input: silicone tubing \varnothing 3/6 mm. 5) Female Luer thread FTLL220. 6) Tee Tube Fittings T220. 7) Tygon pressure tubing 3350. 8) Male Luer lock ring MTL220. 9) Silicone tubing \varnothing 2/5 mm.



The starting volume of the culture should be identical in all culture vessels. When placing the stoppers in the culture vessels ensure that the vessels are well sealed to allow liquid discharge via effluent tubes. It is recommended to insert the effluent Teflon tube few millimeters above the culture surface. The medium inlet stainless steel tube should be higher than the effluent Teflon tube. To maintain the identical biomass volume in all culture vessel, align all outlets of the effluent Teflon tubes to the same level (see Fig. 9) and use identical aeration flow rate in all vessels.

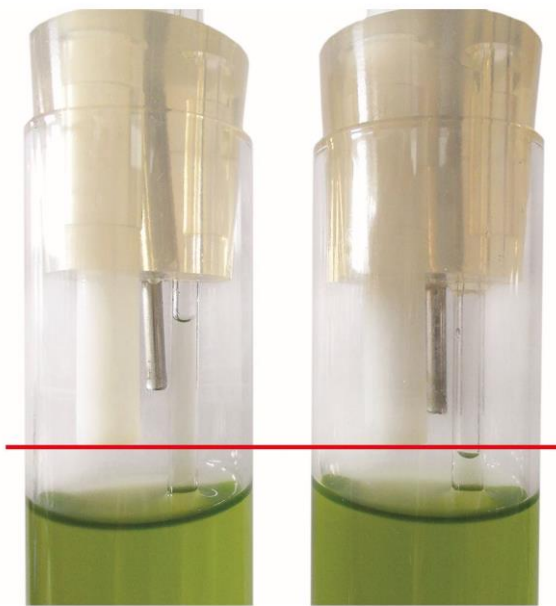





Fig. 9 Effluent tubes: positioning.

	The recommended length of the Norprene peristaltic tubing that is wined around the rotor is approximately 154 mm. If needed the length may be shortened by a few millimeters. Ensure the tubing fit well into the holders and check it occasionally for any signs of wear. If this occurs the tubing should be replaced and the peristaltic pump should be recalibrated.
	Ensure that the ends of all the tubing are always pushed all the way to the end of the Luer Lock fittings. All connections must be tight to prevent any air leakage into the fresh medium dispenser system which would result in improperly function of the system.
	Pliers may be used gently if the connection between male Luer lock and female Luer thread can't be loosened.

- Connect the input of the medium dispenser tubing to the fresh medium stock bottle (see Fig. 10 - 1). Use the metal lid with two ports, silicone ring and silicone tubing (\varnothing 3/6 mm) for this purpose. One port is intended for fresh medium supply and the other port has to stay open to prevent a formation of negative pressure in the bottle as the medium is pumped out. It's possible to use a suitable filter for the open port to prevent a contamination.
- Connect the outlets of medium dispenser tubing with the culture vessels via the medium inlet tubes: pull the silicone tubing on the medium inlet tube. It is recommended to connect the first channel (= first pinch valve) with the first culture vessel, second pinch valve with the second culture vessel and so on.

	<p>The stock bottle with its lid is not included in the delivery. The metal lid with ports and silicone seals are included in the Turbidostat module delivery. The silicone tubing \varnothing 3/6 mm is included in the Multi-Cultivator MC 1000 delivery.</p>
	<p>When setting up the silicone plugs and connecting the gas and medium tubing exercise caution to avoid breaking of the glass bubbling straws during such a manipulation. Also, check that the glass bubbling straws are still placed to the side of the cultivation vessel and do not interfere with the OD measurement system (see Multi-Cultivator Manual for more details).</p>
	<p>The medium overflow waste bottle (refer to Multi-Cultivator MC 1000 Instruction manual) should be of the same volume or larger than the fresh medium stock bottle to avoid the effluent spillage.</p>

- Connect a short piece of silicon tubing (\varnothing 3/6 mm) to the TS Air pump input. Connect the Minisart filter through a Female Luer Thread to the end of the silicon tubing (Fig. 5).
- Connect the TS Air pump output (Fig. 5) through the silicon tubing (\varnothing 3/6 mm) with the Teflon runner of the Multi-Cultivator MC 1000.
- Connect the Turbidostat module to power and switch it on.
- Connect the Turbidostat module to the Photobioreactor control unit PC via the USB communication cable.

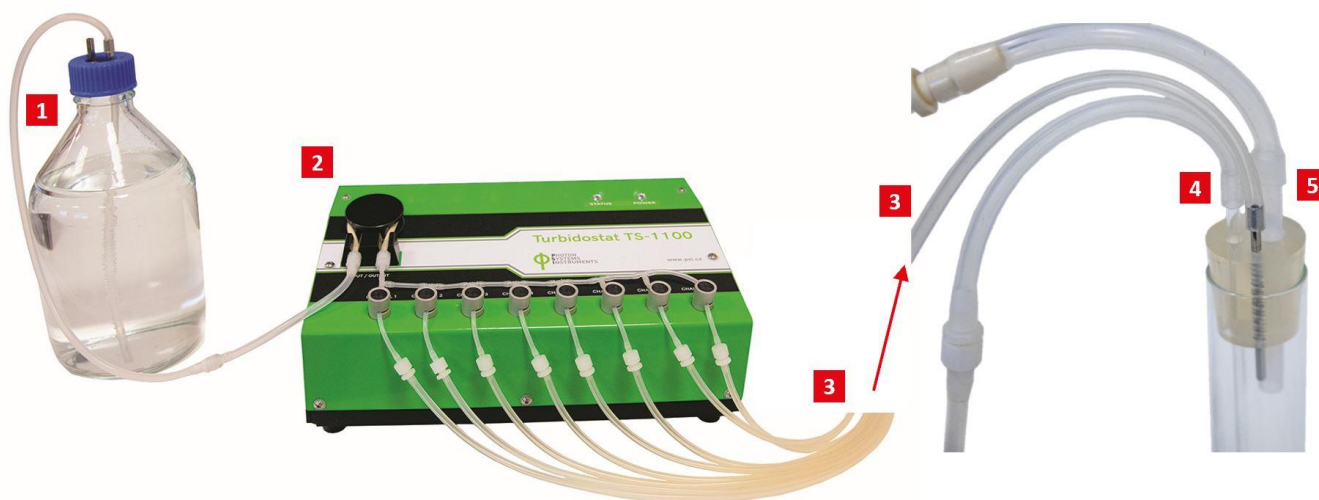

Fig. 10 Connection of Turbidostat module.

1) Fresh medium stock bottle. 2) TS module. 3) Medium inlet tube. 4) Air sparging tube. 5) Effluent teflon tube.

8 OPERATION INSTRUCTIONS

Start the Bioreactor Client. (See Bioreactor Software manual for detailed information about the software.)

The Multi-Cultivator device group is created automatically. However, the Turbidostat module will be put to the <unassigned> group by default. To link it to the correct Multi-Cultivator group, drag & drop the Turbidostat node to the appropriate group. See chapter 2.2 in Bioreactor Software Manual for more details.

Setting of OD regulator

OD regulator is designed to control the biomass concentration during the cultivation in Multi-Cultivator by maintaining a preset OD value in the individual cultivation vessels. OD regulator uses the OD sensors for pinch valves feedback control. Therefore, OD sensors and pinch valves need to be assigned to the OD regulator, refer to Fig. 11 that shows its configuration window.

Click on the appropriate Multi-Cultivator device node and select the OD Regulator #1. Assign the controlling OD sensor (either OD680 or OD720) and a relevant channel (pump/pinch valve) to the selected OD Regulator. OD Regulator #1 is usually appointed to the first cultivation vessel. If the medium dispenser tubing is connected as recommended then TS-pump1 will be assigned to OD Regulator #1. Set the observed OD and appropriate channels for all subsequent OD Regulators.

Setting of turbidostatic pump

The flow rate and maximum medium flow usage for each channel (pump/vessel) can be set in TS-pump folder. See Fig. 12 for configuration window.

Click on the appropriate Turbidostat device node and select TS-pump 1. The rotation direction cannot be changed and the pump rotates always to the right (clockwise) no matter what is selected. The range of the pump flow rate is visible if the cursor is placed in the field. The flow rate of the fresh medium in each channel (i.e. in the individual cultivation vessel) is set independently here.

	<p>Each inserted flow rate must be confirmed by ENTER keyboard key, otherwise it will not become active.</p>
---	---

The Max usage field can be used to monitor a rough total medium consumption for each cultivation vessel. If value specified in Max usage field is exceeded, the TS-pump usage field in the legend of live Graph window is highlighted by soft yellow color.

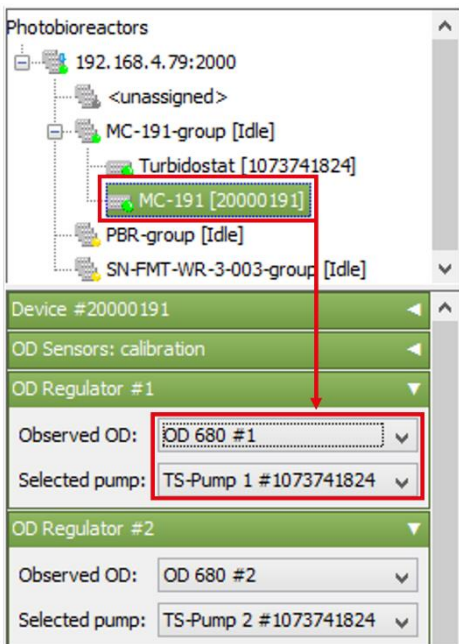

Fig. 11 Configuration window of the OD Regulator.

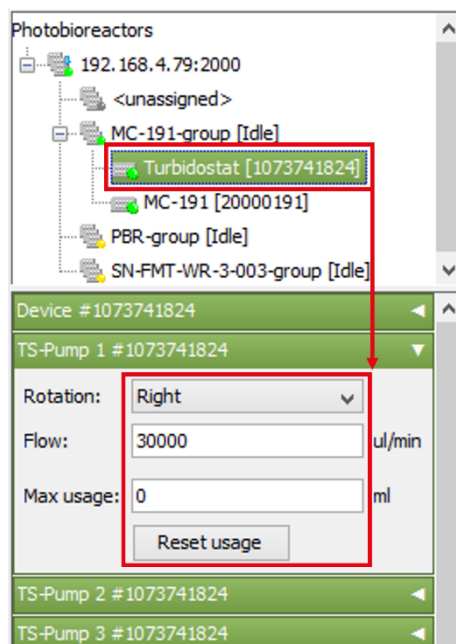

Fig. 12 Configuration window for turbidostatic pump: pump flow rate setting.

Setting of OD regulator protocol

The protocol of OD regulator can be set up to maintain specific OD values over different time phases. The example of protocol in Fig. 13 specifies OD regulation in the range between 0.4 and 0.5 for 16 hours, then no control for 8 hours and again control at preset constant value of OD of 0.6.

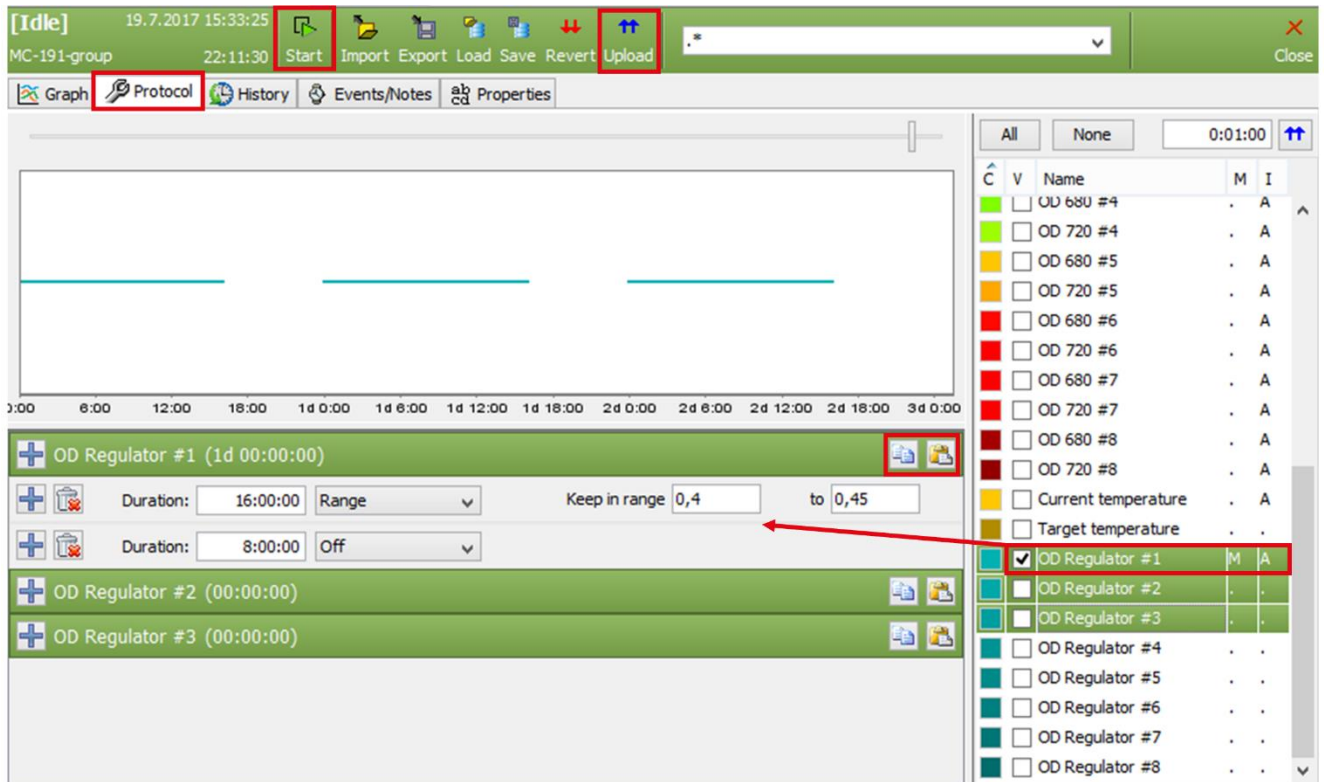

Fig. 13 Protocol configuration window for OD Regulator: setting of the OD sensor.

To set up the OD regulation protocol click on the Protocol tab in the top menu and select OD Regulator #1. Set phase duration, phase mode and OD level. Various settings can be used for different OD Regulators. The setting of one OD Regulator can be copied/pasted to other OD Regulators (available just for the advanced software version).

Each change in protocols must be uploaded to the server to become active. This is handled by **Upload** in experiment tool panel of the top menu. The **Revert** button returns back the non-uploaded changes. The button **Start** starts the experiment and uploads the changes at the same time.

The peristaltic pump starts to pump a fresh medium and therefore dilute the culture when the turbidostatic OD exceeds a preset maximum value of the requested range. The pump stops if the OD value returns to the preset minimum value.

In case, a constant mode of the turbidostatic regulation is used then a deviation from the constant preset value has to be set. This deviation indicates when the pump stops dilute the biomass. Default setting is 2 % below the preset value.

The deviation can be change in the advanced context menu of OD Regulator (see Fig. 14) by right clicking and selecting **Configure >> range**. An example of the range may be 0.1. This setting will ensure that the pump will stop once the turbidostatic OD fall by 10% to 90 % of the preset constant value. If the preset OD value for the turbidostatic cultivation is equal to 1 then the pump will start the dilution once the OD reaches value of 1 and stop the dilution once the OD drops to 0.9.

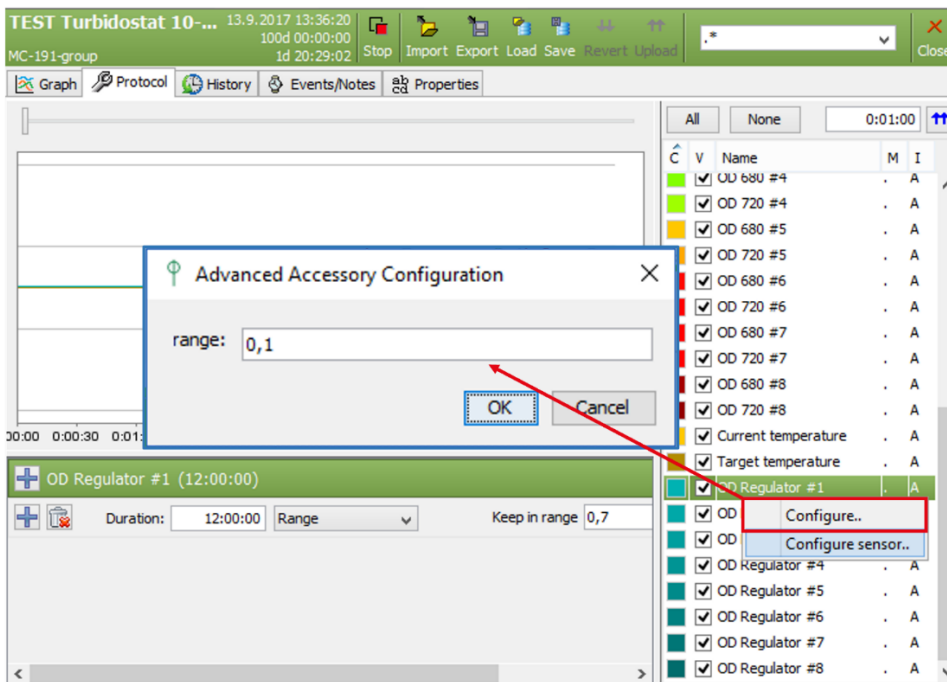

Fig. 14 Advanced OD Regulator configuration.

In the advanced setting, the user can select how the turbidostatic OD value is determined (refer to Fig. 15). The turbidostatic OD is measured by the OD sensor every minute automatically. For the control of the turbidostatic cultivation, the user can select how to obtain the OD from the sensor:

1. only the last measured OD value will be considered
2. the average from the last preset number of measurements
3. the average from the last measurements obtained during the set time period

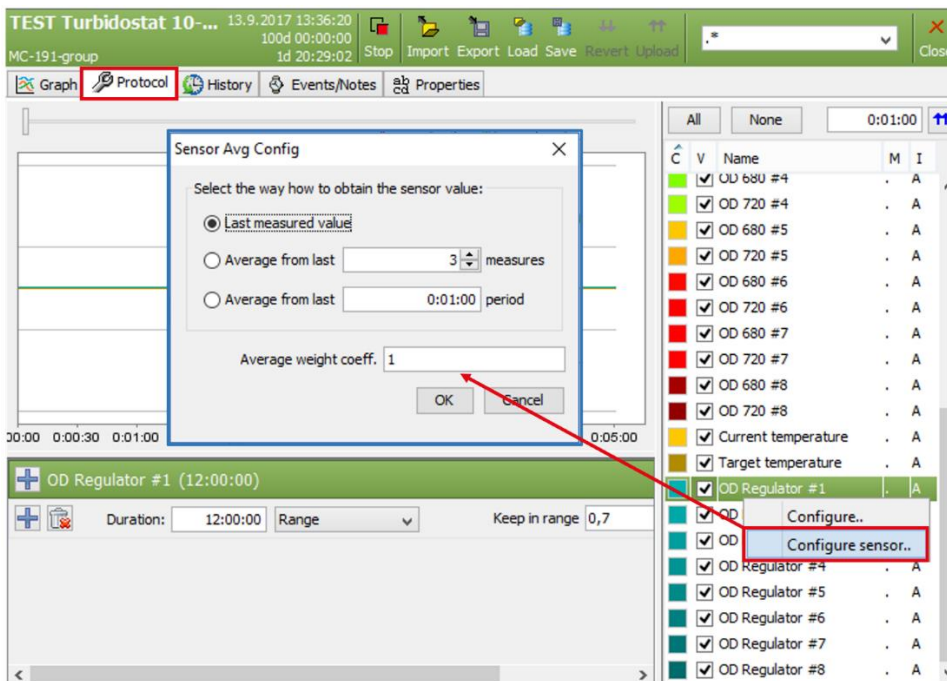

Fig. 15 Advanced setting of OD regulating value calculation.

In case, the average is used for the OD calculation then an arithmetic mean or weighted arithmetic mean can be used. For the arithmetic mean, set the Average weight coefficient equal to 1.

For the weighted arithmetic mean, set into the field Average weight coefficient a multiplier by which each following weight will be lowered (refer to Fig. 15). The latest OD value has always weight equal to 1. Hence, if the coefficient will be set to 0.9 then the latest OD value is weighted by the weight 1, next to last OD value is weighted by the weight 0.9 and previous OD value is weighted by the weight 0.81 etc. In this way, the later measured OD values have higher weight and are more significant for the calculation of the turbidostatic OD average.

Setting of TS Air pump

The use of the inbuilt TS Air pump is recommended for the biomass aeration. The Bioreactor control software allows to switch on and regulate the TS Air pump instead of the standard Air pump. The TS Air pump can be controlled in the range from 25 to 100 %. For the relation between intensity of TS Air pump (%) and its flow rate (l/min) see Fig. 5.

For the control of TS Air pump, switch off the standard Air pump and set any suitable intensity of the TS Air pump in the Protocol window.

9 WARRANTY TERMS AND CONDITIONS

- This Limited Warranty applies only to the Turbidostat module. It is valid for one year from the date of shipment.
- If at any time within this warranty period the instrument does not function as warranted, return it and the manufacturer will repair or replace it at no charge. The customer is responsible for shipping and insurance charges (for the full product value) to PSI. The manufacturer is responsible for shipping and insurance on return of the instrument to the customer.
- No warranty will apply to any instrument that has been (i) modified, altered, or repaired by persons unauthorized by the manufacturer; (ii) subjected to misuse, negligence, or accident; (iii) connected, installed, adjusted, or used otherwise than in accordance with the instructions supplied by the manufacturer.
- The warranty is return-to-base only and does not include on-site repair charges such as labor, travel, or other expenses associated with the repair or installation of replacement parts at the customer's site.
- The manufacturer repairs or replaces faulty instruments as quickly as possible; the maximum time is one month.
- The manufacturer will keep spare parts or their adequate substitutes for a period of at least five years.
- Returned instruments must be packaged sufficiently so as not to assume any transit damage. If damage is caused due to insufficient packaging, the instrument will be treated as an out-of-warranty repair and charged as such.
- PSI also offers out-of-warranty repairs. These are usually returned to the customer on a cash-on-delivery basis.
- Wear & Tear Items (such as sealing, tubing, padding, etc.) are excluded from this warranty. The term Wear & Tear denotes the damage that naturally and inevitably occurs as a result of normal use or aging even when an item is used competently and with care and proper maintenance.

10 LIST OF PICTURES

Fig. 1 Schematic diagram of Turbidostat module TS 1100 coupled with the Multi-Cultivator MC 1000.....	6
Fig. 2 Components of the Turbidostat module.....	7
Fig. 3 Main panel of the Turbidostat module.	8
Fig. 4 Rear panel of the Turbidostat module.	8
Fig. 5 TS Air pump.....	9
Fig. 6 Set up of Turbidostat module for calibration.....	10
Fig. 7 Turbidostatic pump calibrator window.....	10
Fig. 8 Assembling of the fresh medium dispenser tubing.....	11
Fig. 9 Effluent tubes: positioning.	12
Fig. 10 Connection of Turbidostat module.	13
Fig. 11 Configuration window of the OD Regulator.....	14
Fig. 12 Configuration window for turbidostatic pump: pump flow rate setting.....	14
Fig. 13 Protocol configuration window for OD Regulator: setting of the OD sensor.....	15
Fig. 14 Advanced OD Regulator configuration.....	16
Fig. 15 Advanced setting of OD regulating value calculation.....	16